

# ALTITUDE™ 42 DIRECT VENT GAS FIREPLACE



## Specifications

Model	BTU	Width		Height		Depth		Glass Size
		Actual	Framing	Actual	Framing	Actual	Framing	
A36NTE A36PTE	30,000	41 13/16	43 1/4	45 7/16	47 5/8	18 7/8	19	25 115/16 x 34 3/4

## Dimensions

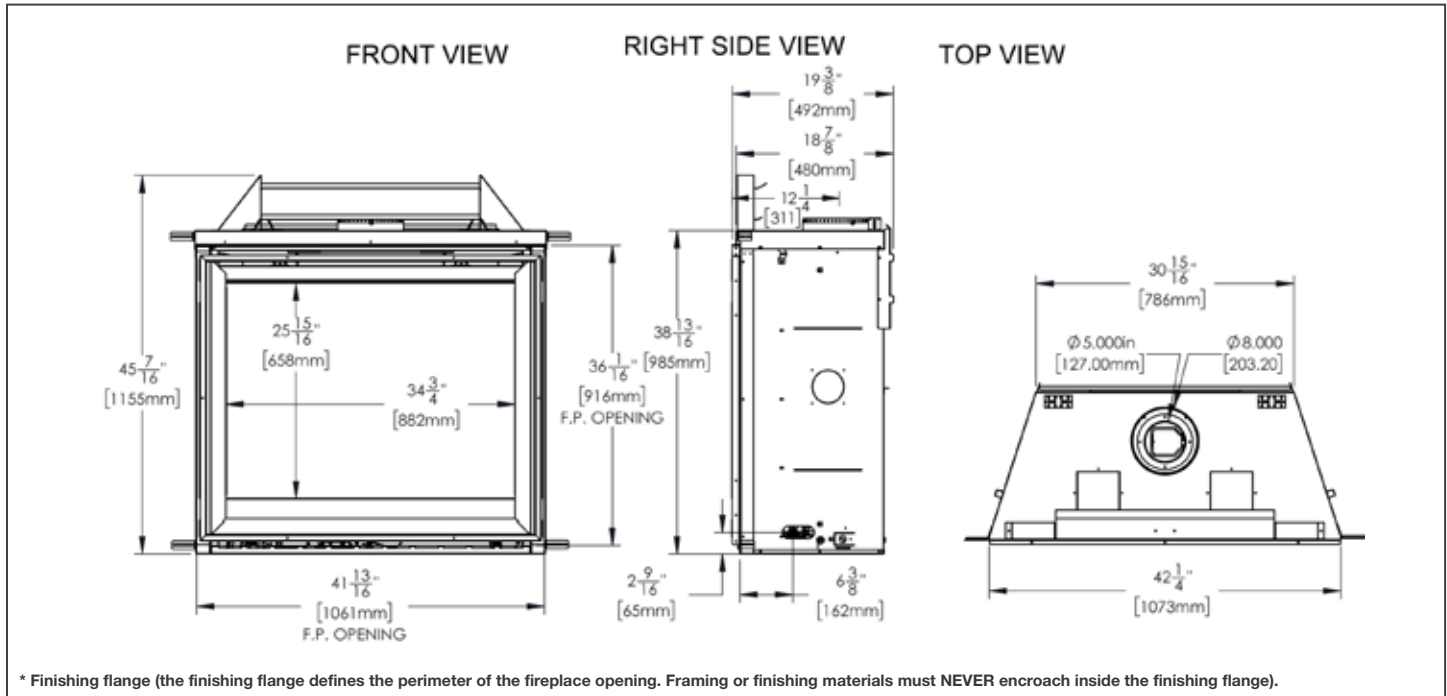

## Appliance Location

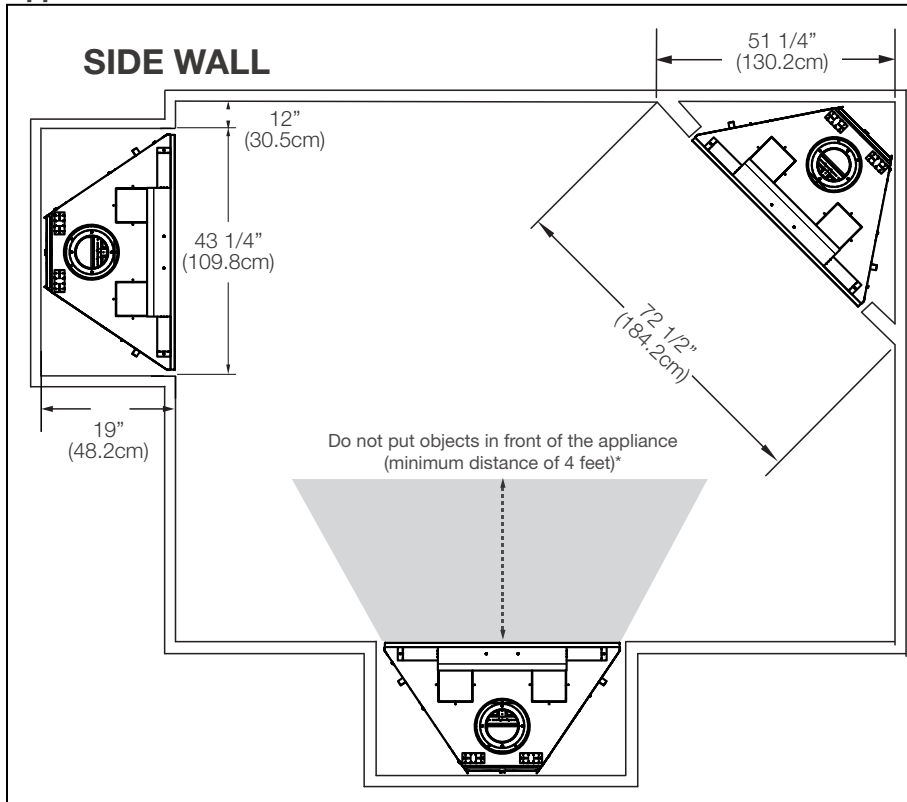

## Combustible Mantel Clearances

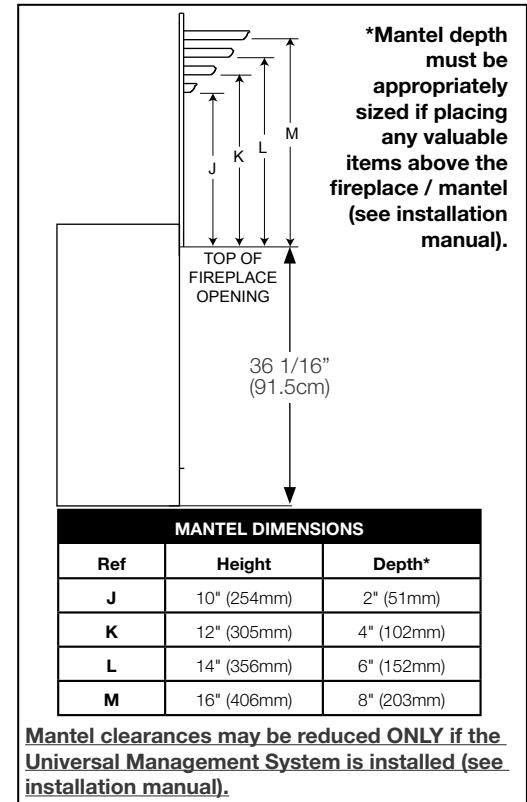

W415-4134 / 01.13.23

# ALTITUDE™ 42 DIRECT VENT GAS FIREPLACE



Product information provided is not complete and is subject to change without notice. Please consult the installation manual for the most up to date installation information.

## Wall Penetration

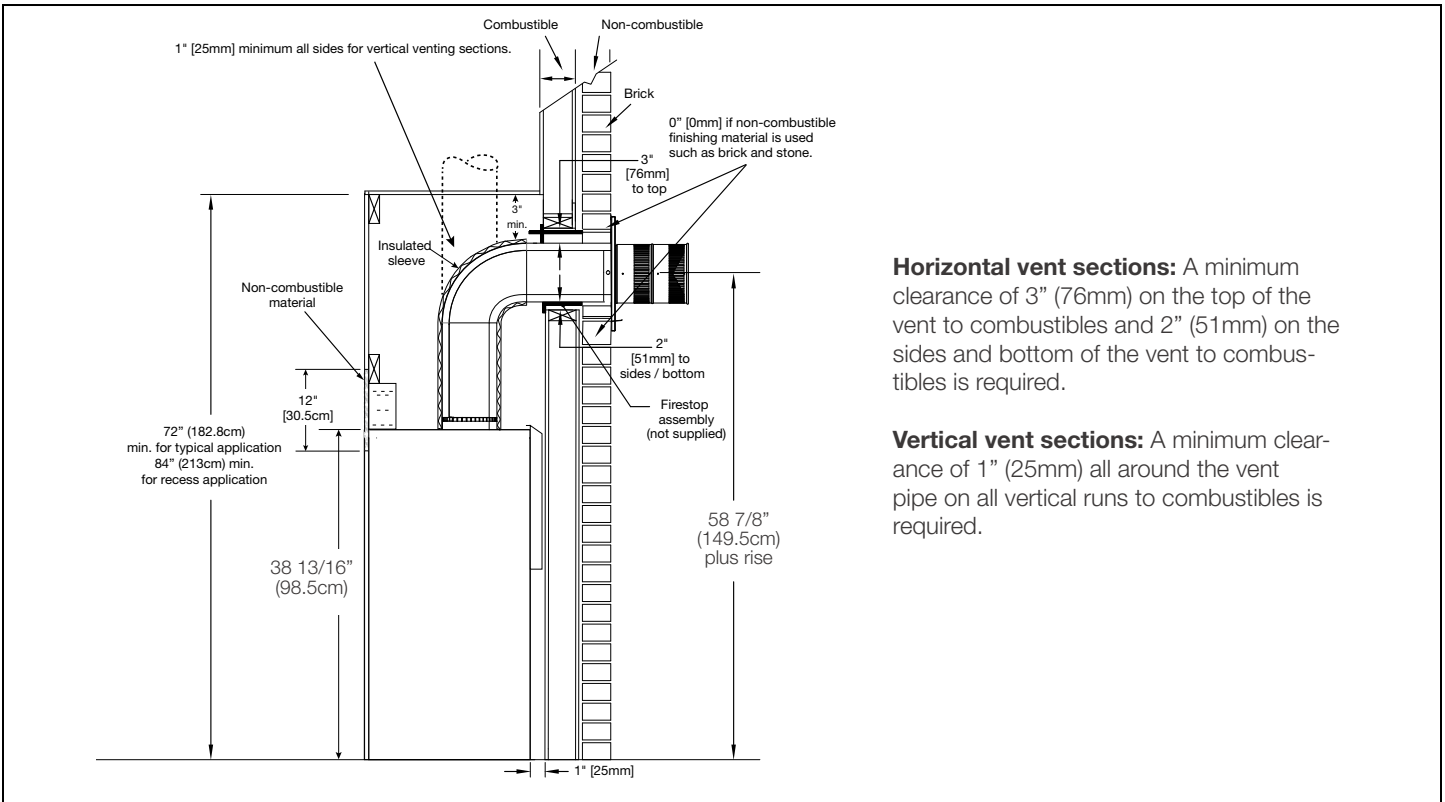

## Flush & Recessed Framing

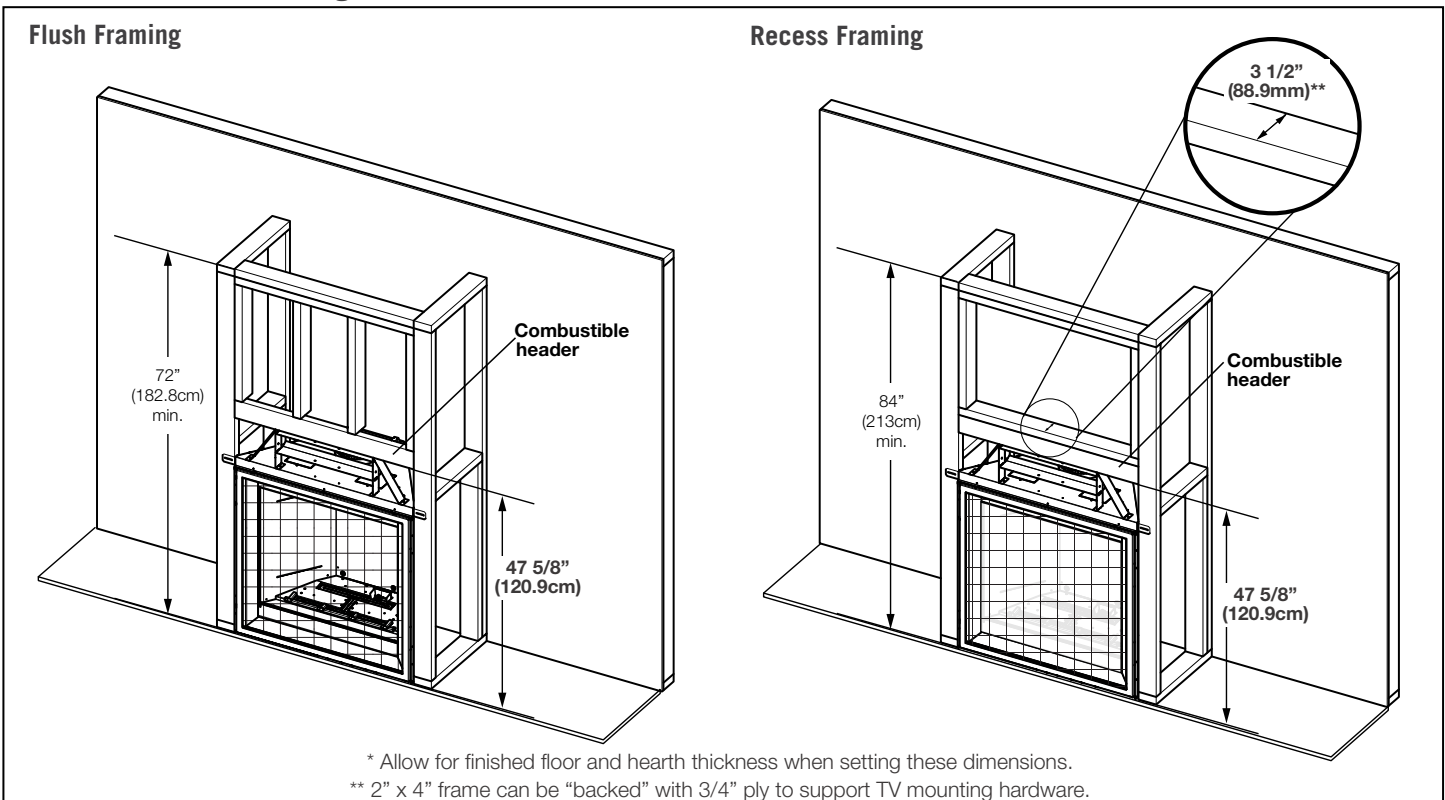

W415-4134 / 01.13.23

## Spécifications

Modèle	BTU	Largeur		Hauteur		Profondeur		Dimensions de Vision
		Actual	Framing	Actual	Framing	Actual	Framing	
A36NTE	30 000	41 13/16	43 1/4	45 7/16	47 5/8	18 7/8	19	25 115/16 x 34 3/4
A36PTE								

## Dimensions

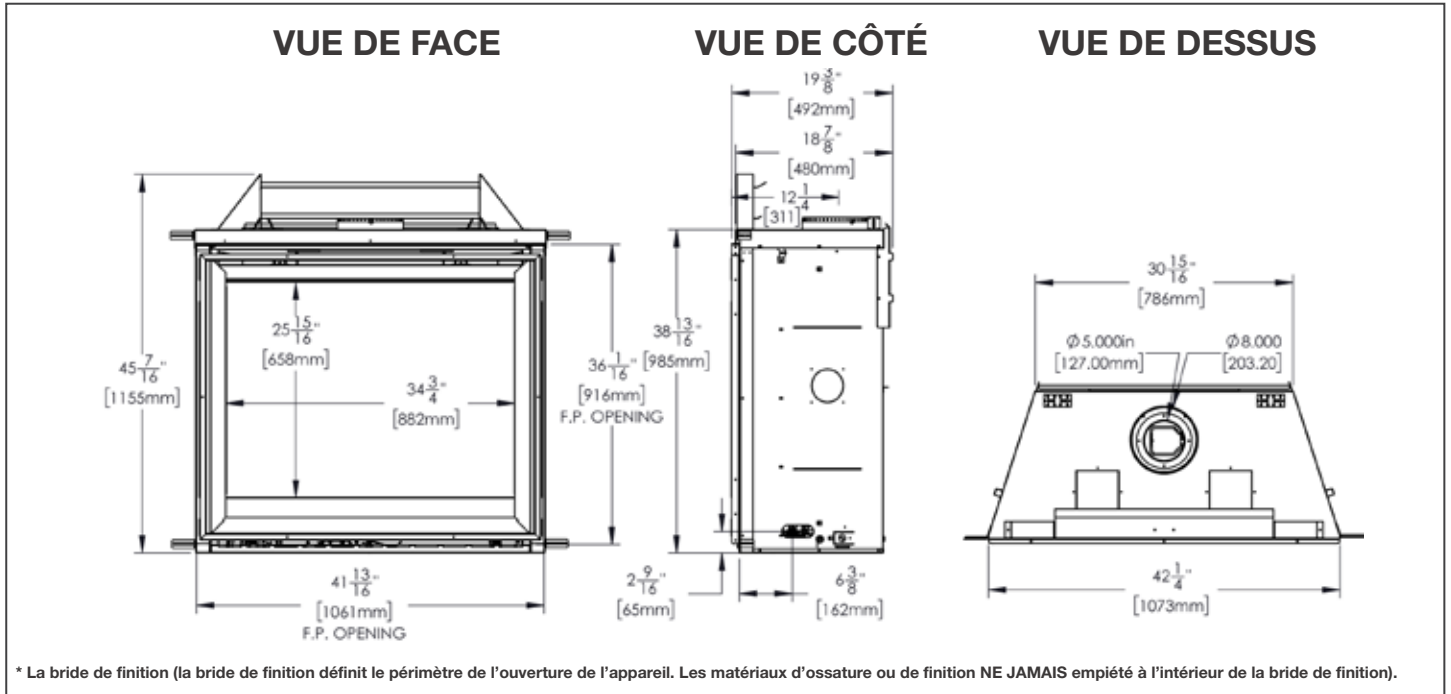

## Emplacement de l'Appareil

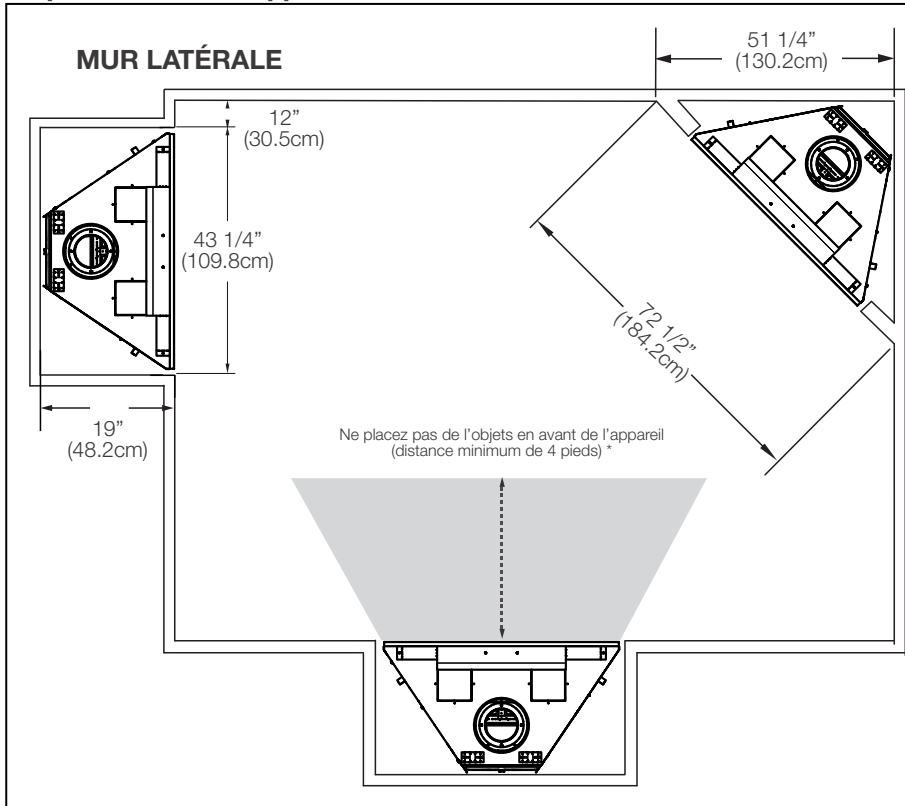

## Dégagements Combustible de la Tablette

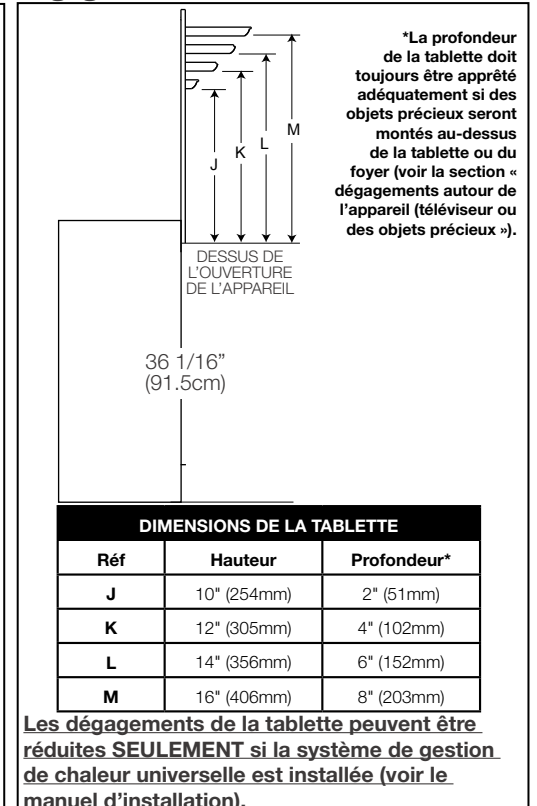

L'information du produit fourni n'est pas complet et est sujet de changer sans préavis. Consultez le manuel d'installation pour information d'installation actuel.

## Pénétration du Mur

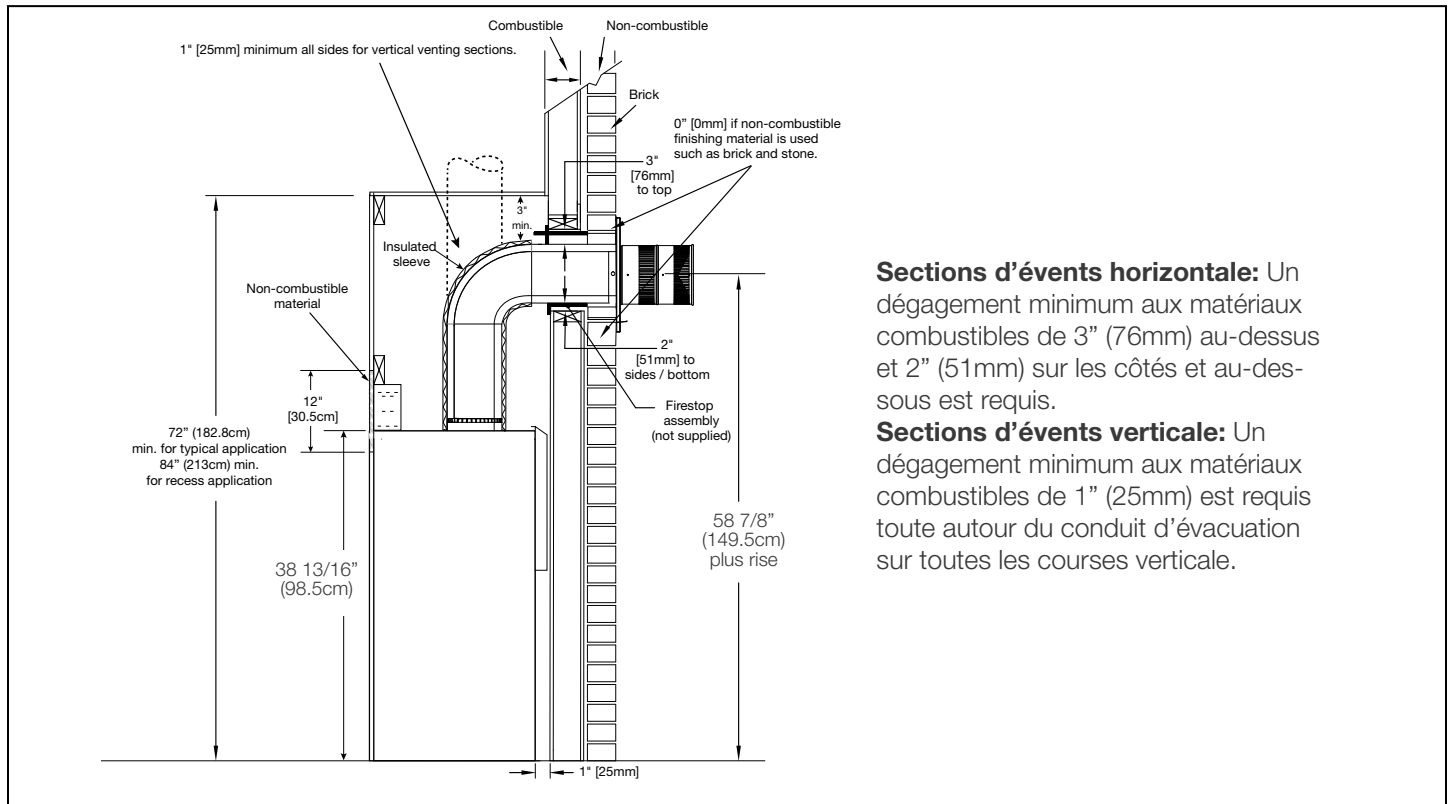

**Sections d'évents horizontale:** Un dégagement minimum aux matériaux combustibles de 3" (76mm) au-dessus et 2" (51mm) sur les côtés et au-dessous est requis.

**Sections d'évents verticale:** Un dégagement minimum aux matériaux combustibles de 1" (25mm) est requis toute autour du conduit d'évacuation sur toutes les courses verticale.

## Encadrement Affleuré et Encastré

