



THE OUTDOOR
GREATROOM
COMPANY

The Westport Fire Pit Table

Installation Instructions for WP-1616 and WP-INT



IMPORTANT

Please consult your Crystal Fire Manual or INT-EZ manual for detailed instructions and important information related to the burner installation including: lighting and operating instructions, safety information, and proper tightening of connections with two wrenches.

DO NOT ATTEMPT TO INSTALL CRYSTAL FIRE BURNER OR INTRIGUE WITHOUT FIRST CONSULTING THE PROPER MANUAL

Contents

Required Tools.....	2
Included with your Fire Pit.....	3
Fire Pit Assembly Instructions.....	4
Burner Installation WP-1616.....	5-7
Position Your Propane Tank.....	8
Glass Installation.....	9
Burner Installation WP-INT.....	10-11
Warranty Information.....	12

Required Tools



- **Utility Knife**
To cut and remove packaging



- **Two Open Ended Wrenches**
To secure gas connections



- **Leather Gloves**
To protect hands from glass and sharp edges during installation



- **One AAA Battery (WP-1616) or 2 D-Cell Batteries (WP-INT)**



- **Power Drill with Philips head bit**
Required for Electric Spark igniter installation
To attach mounting brackets to secure tile top to base.



- **Philips screw driver**
To attach control panel for WP-INT



- **At least Two people are required for this installation**

Included With Your Fire Pit

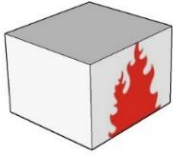

CF-1616-PTR Burner

OR

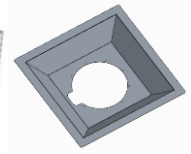

INT-EZ and Trim



WP-BASE



WP-TILETOP



Top Attachment Bracket (2)



Self-tapping Philips Head Screws (8)



**(WP-INT ONLY)
6 lbs. Tumbled Lava Rock (LAV-TMB)**

Fire Pit Assembly Instructions

1. Carefully remove product from packaging. Make sure that all parts are included and undamaged. Ensure you have the proper tools for assembly.
2. Place **WP-BASE** into the final location where you want your fire pit.
3. Place **WP-TILETOP** onto **WP-BASE**. Position the top so that the base is centered in the opening.



4. Using a power drill and **Self Tapping Philips Head Screws** provided, attach **Top Attachment Brackets** to secure **WP-TILETOP** to **WP-BASE** as shown in the figure below. Secure each attachment bracket using 4 screws.

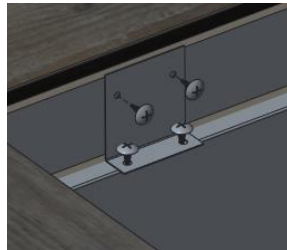
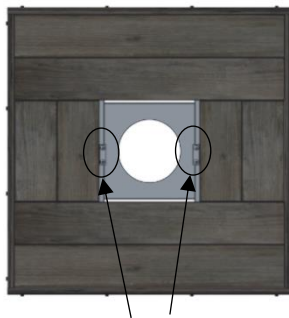

Mounting Bracket Locations

Burner Installation (WP-1616)

Read and understand your Crystal Fire owner's manual before beginning burner hookups or using the device.

Do not use Teflon tape or pipe sealant on flare fittings.

1. Attach Natural Gas supply line or included black rubber propane hose/regulator (depending on gas type) to control valve.

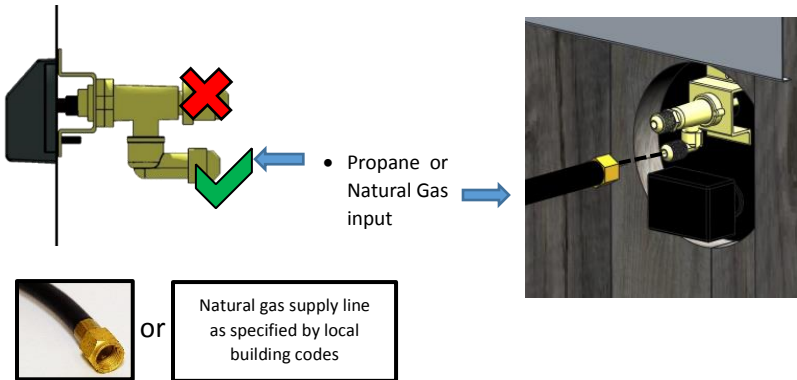

TIGHTEN CONNECTIONS SECURELY WITH TWO WRENCHES

Ensure all connections are secure and leak free before using fire pit.

2. Lay the burner upside down on a flat, soft surface to avoid scratching the metal trim. Ensure the correct orifice is installed for the fuel type you are using (see Crystal Fire user manual included with burner for orifice sizing information). Attach the included metal flex hose to the burner.

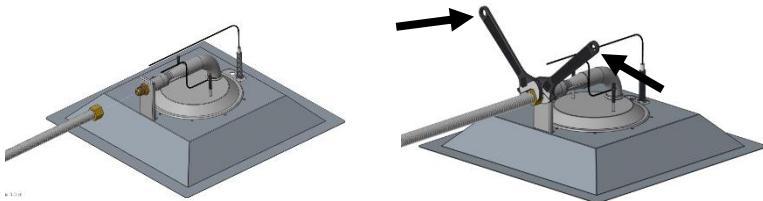

TIGHTEN CONNECTIONS SECURELY WITH TWO WRENCHES

Ensure all connections are secure and leak free before using fire pit.

3. Remove access door to fire pit and orient the burner in the Fire Pit as shown below.

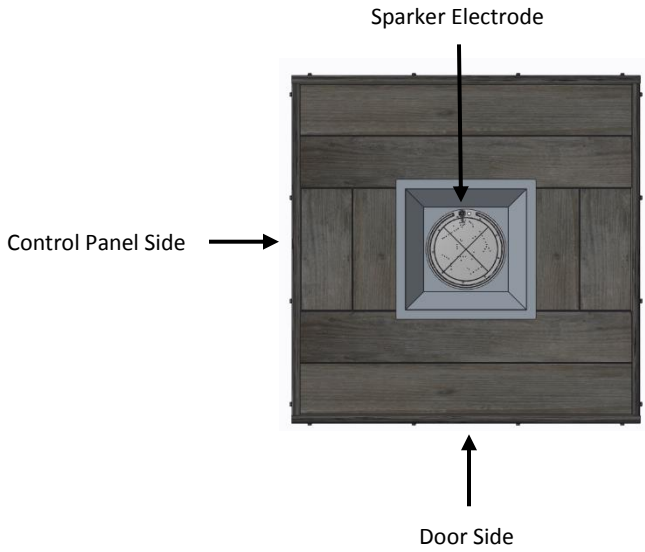

4. Attach Flex Line from burner to control valve as shown below.

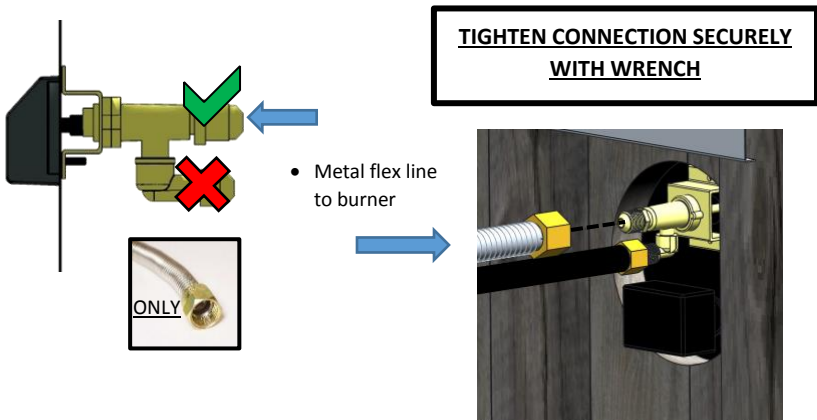

5. Install Sparker box into control panel as shown below. Insert AAA Battery with Positive (+) end facing out. To ensure sparker box is working correctly, press button and listen for sparking behind the sparker box.

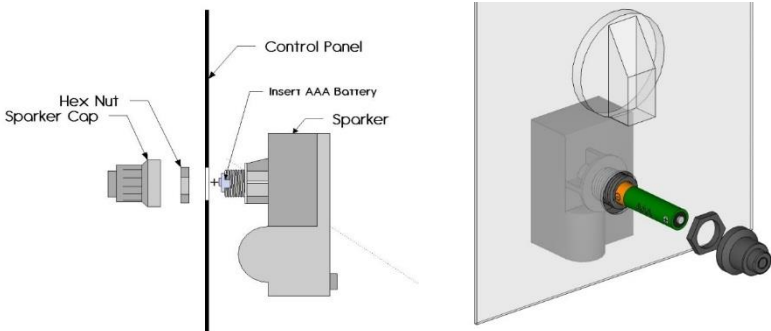

6. Connect sparker wire and ground wire from burner to sparker box as shown below. Ensure good contact between connections. Test sparking system by pressing the button and listening/watching for the spark between the electrode and sparking tab at the burner surface. Consult the troubleshooting section of the Crystal Fire Manual if spark is weak, intermittent, or not present.

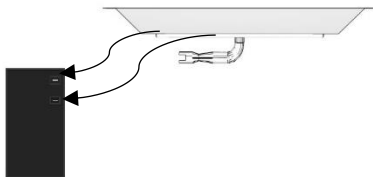

After installing igniter and making gas connections, verify that gas connections are tight and that no leaks are present using a solution of soapy water or a commercially available leak-check solution.

Position Your Tank (If Applicable)



- Open the access door and connect the propane hose/regulator to the propane tank and hand tighten (DO NOT USE A WRENCH).
- Insert the propane tank by tipping at a 45 degree angle as shown in the picture in order to fit tank into access door opening.
- Tip tank upright into final position once inside the fire pit.
- Ensure the tank is seated properly and stays vertical during operation and while not in use.
- Ensure that no hoses, wires or anything else is kinked or touching the bottom of the burner

Glass Installation



- Scatter all the included glass beads evenly onto burner surface.

DO NOT OPERATE CRYSTAL FIRE BURNER WITHOUT INCLUDED GLASS MEDIA OR OTHER APPROVED FIRE MEDIA

IMPORTANT

Please consult your Crystal Fire instruction manual for detailed instructions and important information related to burner installation, including: lighting and operating instructions, safety information, and proper tightening of connections with two wrenches.

DO NOT ATTEMPT TO INSTALL CF-1616 CRYSTAL FIRE BURNER WITHOUT FIRST CONSULTING THE CRYSTAL FIRE OWNER'S MANUAL.

WARNING

After consulting the manual and following instructions, remember: before operating, all gas connections must be fully checked for leaks

Burner Installation (WP-INT)

Read and understand your INT-EZ owner's manual before beginning burner installation or using the device.

1. Assemble INT-EZ with burner trim. Refer to INT-EZ manual before attempting to install.

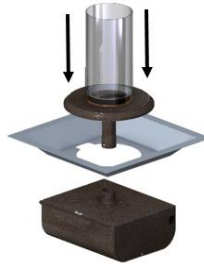

2. Make wire connections from burner to control panel:
 - a. Use spade connectors provided to connect the wires from the intrigue (Brown) to the wires from the control panel (Black).

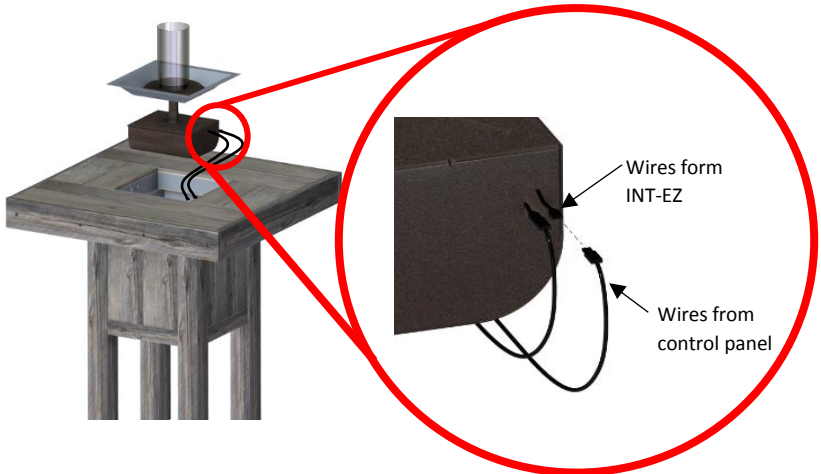

- Drop INT-EZ and trim into fire pit. Orient the INT-EZ Base so that the access door is easily accessible.

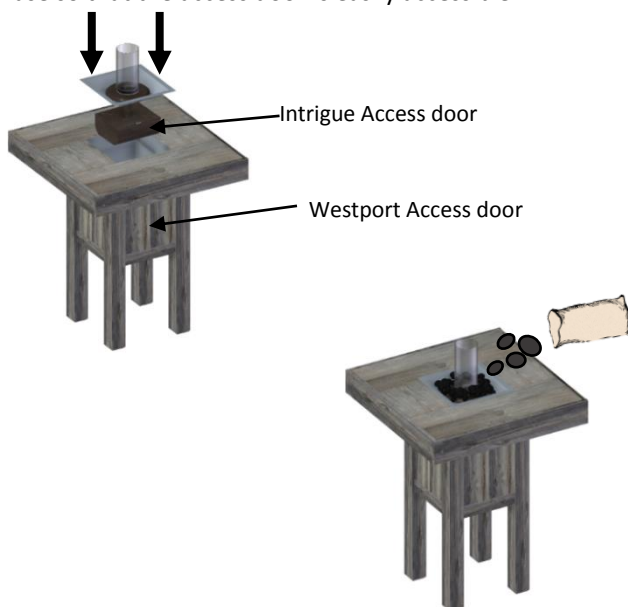

- Carefully install tumbled lava rock; be careful not to damage the glass cylinder when installing lava rock.

IMPORTANT

Please consult your INT-EZ instruction manual for detailed instructions and important information related to burner installation, including: lighting and operating instructions, and safety information.

DO NOT ATTEMPT TO INSTALL INT-EZ BURNER WITHOUT FIRST CONSULTING THE INT-EZ OWNER'S MANUAL.

Warranty: Fire pit tables are covered under a 1-year manufacturer's warranty. Please visit <http://www.outdoorrooms.com/warranty-form> to register your product.

Thank you for purchasing an
Outdoor GreatRoom Company
product! This fire pit was made with
pride in the USA.



	<p>WARNING: This product can expose you to chemicals including Carbon Monoxide and Benzene which are known to the State of California to cause cancer or birth defects or reproductive harm. For more information, visit www.P65Warnings.ca.gov</p>
---	---

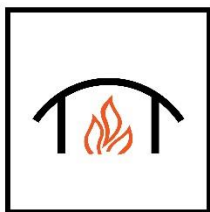

14400 Southcross Drive West • Suite 100 • Burnsville, MN 55306
Toll Free: 1-866-303-4028 • Sales@OutdoorRooms.com