

PLATINUM SMART-HEAT™ GAS

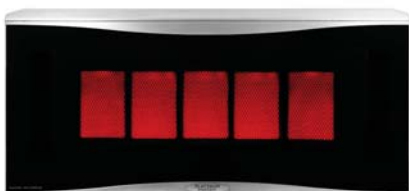

Top quality performance and the looks to match

The Platinum Smart-Heat™ Gas range represents the absolute pinnacle of outdoor heating products, combining elegant aesthetics with industry-leading performance to offer value and reliability to premium venues and homes. Able to directionally project a comfortably diffused radiant heat deeply into open outdoor spaces, the Platinum Smart-Heat™ Gas is the only gas heater in the world that utilizes glass-ceramic technology to manipulate infrared energy while achieving unparalleled wind resistance.

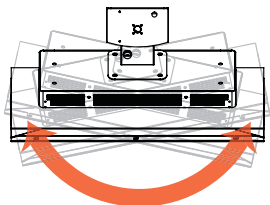
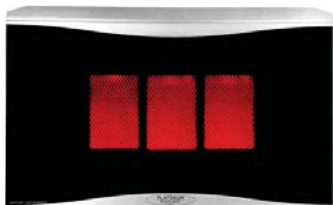
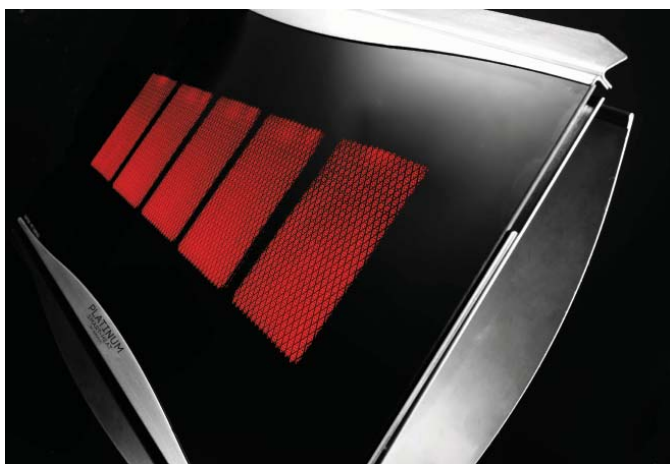
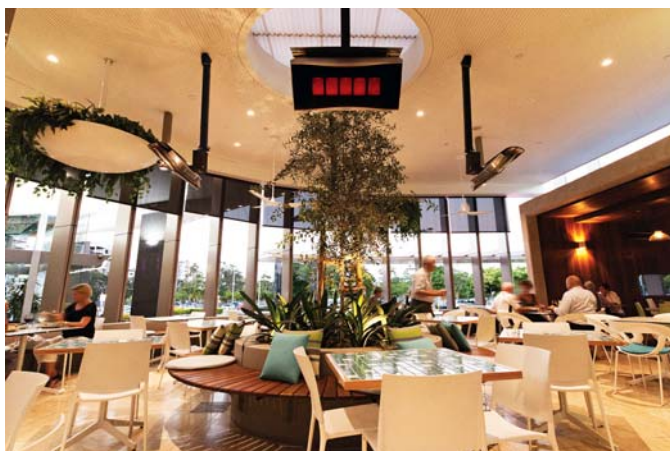

US0717PG

FEATURES

Tinted Glass-Ceramic Screen

The Platinum's signature screen spreads comfort evenly across an area while emitting a soft red glow

Ceramic Efficiency

Slow-release ceramic burners efficiently combust gas to fuel the most environmentally friendly gas-fired heating method available

Elegantly Subtle Design

Equally at home as the stunning centerpiece or supporting from the sidelines

Unrivalled Coverage

Projects comfort evenly across a wide range while reaching deeply into open areas

Patented Direct Ignition

Automated direct ignition eliminates the need for a pilot, resulting in instantaneous ignition

Sturdy Construction

Durable stainless steel structures house components of the highest quality, fueling reliable performance

Ultimate Wind Resistance

Patented screen and ionization probe technology enables remarkable wind resistance, functioning reliably in winds of up to 18km/h or 11mph

Ease Of Use

Smart system compatibility and automated re-ignition allows users to simply set and forget

Versatile Mounting

Reclaim valuable floor space through fixed heating with a range of ceiling and wall mounting options

Directional Control

Easy pivot bracket offers adjustable heat direction and coverage

Wireless Control Capabilities

Genuine wireless control accessories allow seamless integration of remote heater control

DIMENSIONS

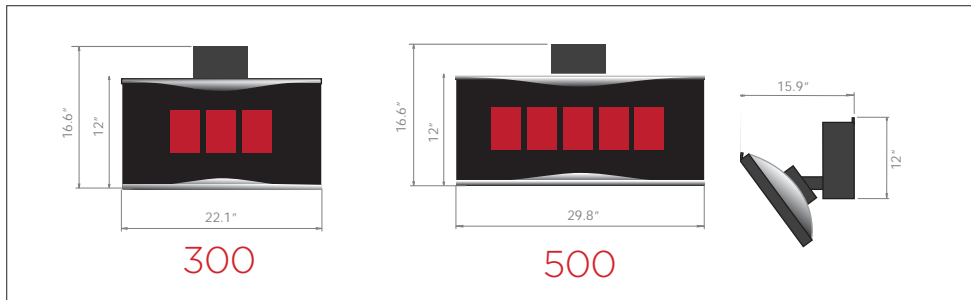

SPECIFICATIONS

Model		300 Series	500 Series
Part no.	LPG ^{1,2}	BH0110002-1	BH0110004-1
	Natural Gas ^{1,2}	BH0110001-1	BH0110003-1
Heat Deflector part no.		BH3030001-1	BH3030002-1
Ceiling Poles		5 pole lengths to suit ceiling heights of 10.5', 11.2', 11.8', 12.5' and 13' (contact Bromic Heating for more information)	
Heat Output (on LPG and NG)		23,600 BTU	39,800 BTU
Approximate area heated (ft ²)		160 ft ²	215 ft ²
Gas connection		1/2" NPT Female	1/2" NPT Female
Electrical connection		110V/2A, 3-pin insulated plug	110V/2A, 3-pin insulated plug
Dimension (WxDxH)		22.1" x 16.6" x 15.9"	29.8" x 16.6" x 15.9"
Min. distance to combustible materials ² (without heat deflector) ² (with heat deflector) ²		Side: 36"(3')	
		Above (to ceiling): 36"(3')	
		Above (to ceiling): 14"	
Weight (lbs) Including wall bracket		45lb	54lb

¹Must only be installed by a licensed technician. Must complete "Pre-Installation Checklist" before installing. ²The temperature will not exceed 14.9°F above the ambient temperature at specified distances. Please consult material manufacturer for temperature ratings and suitability. Bromic Heating takes no responsibility for material compliance.

HEATING AREAS:

300 Series

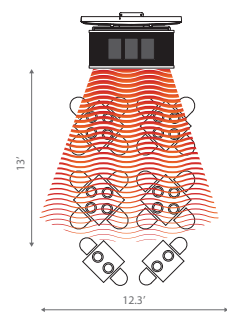

Heats approx. 160ft²
23,600 BTU heating power

500 Series

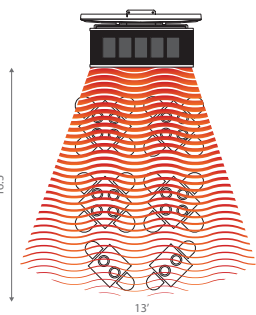

Heats approx. 215ft²
39,800 BTU heating power

*Heat area dependent on ambient temperature and wind. Optimum conditions experienced at approx 60°F & in a low wind covered environment.

MINIMUM INSTALLATION CLEARANCES WALL MOUNTING

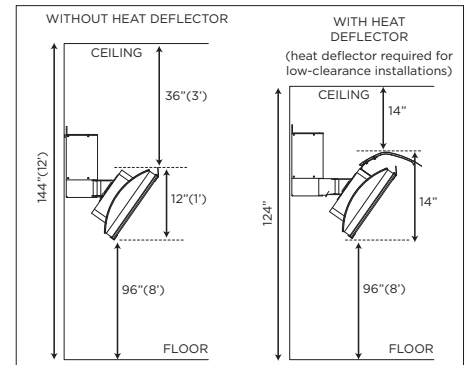

*Non-residential indoor 2500mm

MINIMUM INSTALLATION CLEARANCES CEILING MOUNTING

